

## 阅读申明

- 1.本站收集的数据手册和产品资料都来自互联网，版权归原作者所有。如读者和版权方有任何异议请及时告之，我们将妥善解决。
- 2.本站提供的中文数据手册是英文数据手册的中文翻译，其目的是协助用户阅读，该译文无法自动跟随原稿更新，同时也可能存在翻译上的不当。建议读者以英文原稿为参考以便获得更精准的信息。
- 3.本站提供的产品资料，来自厂商的技术支持或者使用者的心得体会等，其内容可能存在描述上的差异，建议读者做出适当判断。
- 4.如需与我们联系，请发邮件到marketing@iczoom.com，主题请标有“数据手册”字样。

## Read Statement

1. The datasheets and other product information on the site are all from network reference or other public materials, and the copyright belongs to the original author and original published source. If readers and copyright owners have any objections, please contact us and we will deal with it in a timely manner.
2. The Chinese datasheets provided on the website is a Chinese translation of the English datasheets. Its purpose is for reader's learning exchange only and do not involve commercial purposes. The translation cannot be automatically updated with the original manuscript, and there may also be improper translations. Readers are advised to use the English manuscript as a reference for more accurate information.
3. All product information provided on the website refer to solutions from manufacturers' technical support or users the contents may have differences in description, and readers are advised to take the original article as the standard.
4. If you have any questions, please contact us at marketing@iczoom.com and mark the subject with "Datasheets" .

## Thermally-Enhanced High Power RF LDMOS FET 85 W, 2500 – 2700 MHz

### Description

The PTFA260851E and PTFA260851F are 85-watt LDMOS FETs designed for WiMAX power amplifier applications in the 2500 to 2700 MHz band. Features include input and output matching, and thermally-enhanced packages with slotted or earless flanges. Manufactured with Infineon's advanced LDMOS process, these devices provide excellent thermal performance and superior reliability.

PTFA260851E  
Package H-30248-2

PTFA260851F  
Package H-31248-2

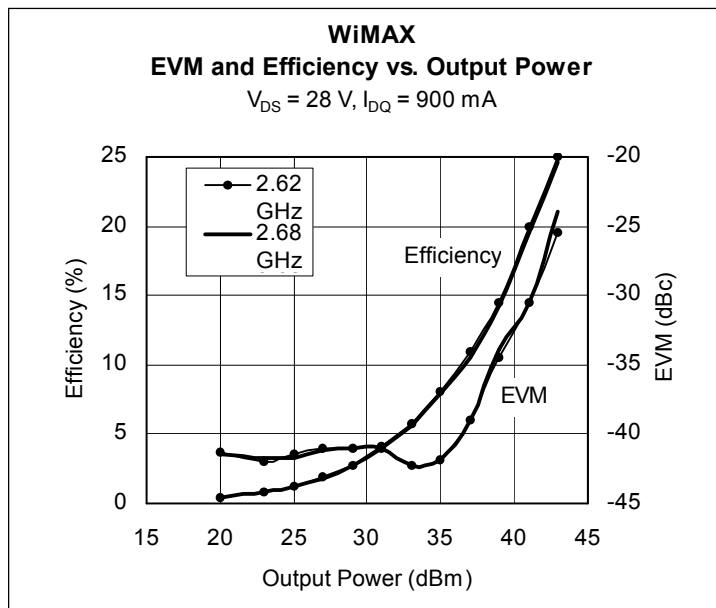
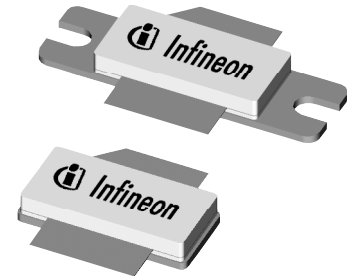

### Features

- Thermally-enhanced, Pb-free and RoHS-compliant packages
- Broadband internal matching
- Typical WiMAX performance at 2680 MHz, 28 V
  - Average output power = 16 W
  - Linear Gain = 14 dB
  - Efficiency = 22%
  - Error Vector Magnitude = -29 dB
- Typical CW performance, 2680 MHz, 28 V
  - Output power at P-1dB = 100 W
  - Efficiency = 47%
- Integrated ESD protection: Human Body Model, Class 2 (minimum)
- Excellent thermal stability, low HCI drift
- Capable of handling 10:1 VSWR @ 28 V, 85 W (CW) output power

### RF Characteristics

**WiMAX Measurements** (not subject to production test—verified by design/characterization in Infineon test fixture)

$V_{DD} = 28\text{ V}, I_{DQ} = 900\text{ mA}, P_{OUT} = 16\text{ W}$  average,  $f = 2680\text{ MHz}$ , modulation = 64 QAM 2/3, channel bandwidth = 3.5 MHz, sample rate = 4 MHz

Characteristic	Symbol	Min	Typ	Max	Unit
Gain	$G_{ps}$	—	14	—	dB
Drain Efficiency	$\eta_D$	—	22	—	%
Error Vector Magnitude	EVM	—	-29	—	dB

All published data at  $T_{CASE} = 25^\circ\text{C}$  unless otherwise indicated

**ESD:** Electrostatic discharge sensitive device—observe handling precautions!

## RF Characteristics (cont.)

### Two-tone Measurements (tested in Infineon test fixture)

$V_{DD} = 28\text{ V}$ ,  $I_{DQ} = 900\text{ mA}$ ,  $P_{OUT} = 85\text{ W PEP}$ ,  $f = 2680\text{ MHz}$ , tone spacing = 1 MHz

Characteristic	Symbol	Min	Typ	Max	Unit
Gain	$G_{ps}$	13	14	—	dB
Drain Efficiency	$\eta_D$	33	36	—	%
Intermodulation Distortion	IMD	—	-30	-28	dBc

## DC Characteristics

Characteristic	Conditions	Symbol	Min	Typ	Max	Unit
Drain-Source Breakdown Voltage	$V_{GS} = 0\text{ V}$ , $I_{DS} = 10\text{ mA}$	$V_{(BR)DSS}$	65	—	—	V
Drain Leakage Current	$V_{DS} = 28\text{ V}$ , $V_{GS} = 0\text{ V}$	$I_{DSS}$	—	—	1.0	$\mu\text{A}$
	$V_{DS} = 63\text{ V}$ , $V_{GS} = 0\text{ V}$	$I_{DSS}$	—	—	10.0	$\mu\text{A}$
On-State Resistance	$V_{GS} = 10\text{ V}$ , $V_{DS} = 0.1\text{ V}$	$R_{DS(on)}$	—	0.095	—	$\Omega$
Operating Gate Voltage	$V_{DS} = 28\text{ V}$ , $I_{DQ} = 900\text{ mA}$	$V_{GS}$	2.0	2.5	3.0	V
Gate Leakage Current	$V_{GS} = 10\text{ V}$ , $V_{DS} = 0\text{ V}$	$I_{GSS}$	—	—	1.0	$\mu\text{A}$

## Maximum Ratings

Parameter	Symbol	Value	Unit
Drain-Source Voltage	$V_{DSS}$	65	V
Gate-Source Voltage	$V_{GS}$	-0.5 to +12	V
Junction Temperature	$T_J$	200	$^{\circ}\text{C}$
Total Device Dissipation	$P_D$	437.5	W
		Above 25 $^{\circ}\text{C}$ derate by	2.5
Storage Temperature Range	$T_{STG}$	-40 to +150	$^{\circ}\text{C}$
Thermal Resistance ( $T_{CASE} = 70^{\circ}\text{C}$ , 85 W CW)	$R_{\theta JC}$	0.4	$^{\circ}\text{C}/\text{W}$

## Ordering Information

Type and Version	Package Type	Package Description	Marking
PTFA260851E V1	H-30248-2	Thermally-enhanced slotted flange, single-ended	PTFA260851E
PTFA260851F V1	H-31248-2	Thermally-enhanced earless flange, single-ended	PTFA260851F

**Typical Performance** (data taken in a production test fixture)

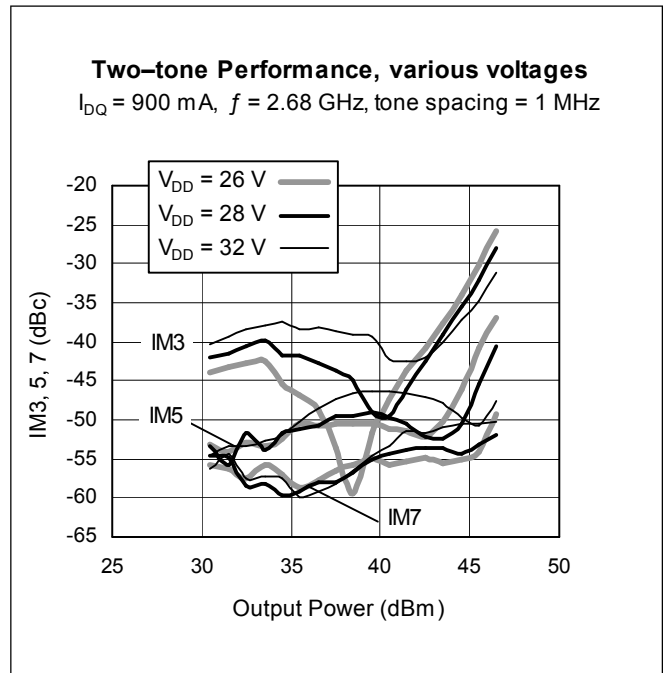
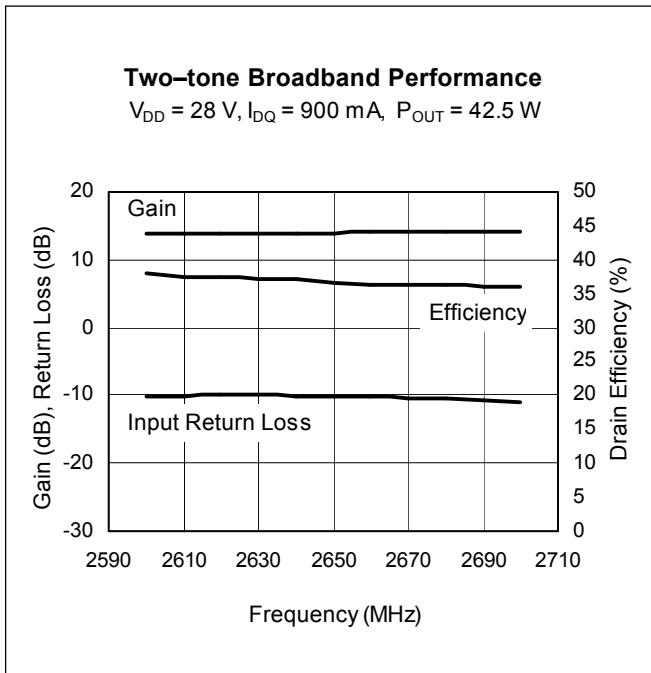
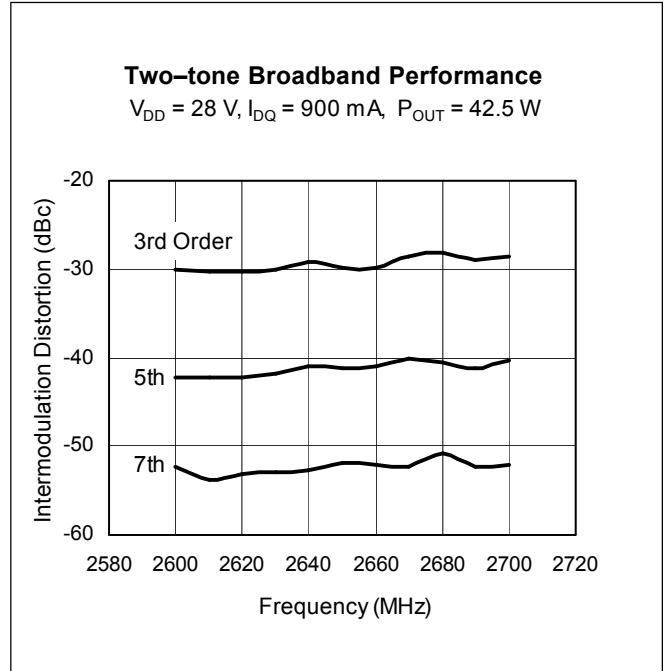
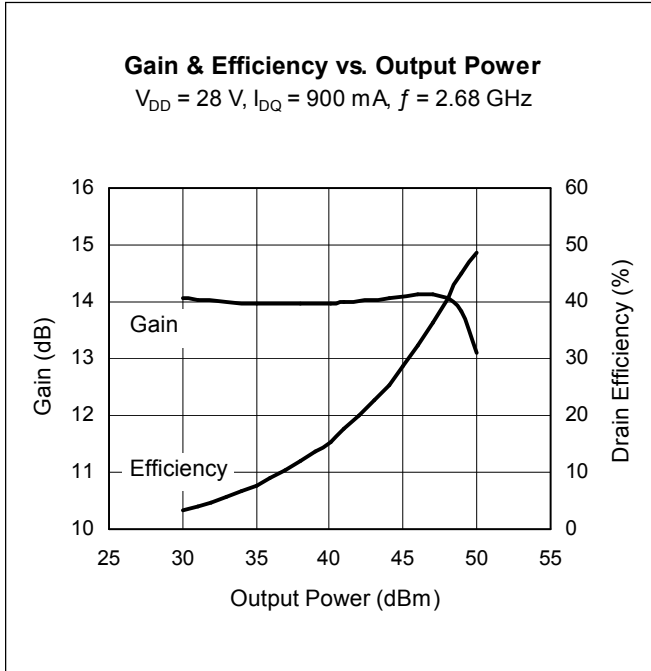

Typical Performance (cont.)

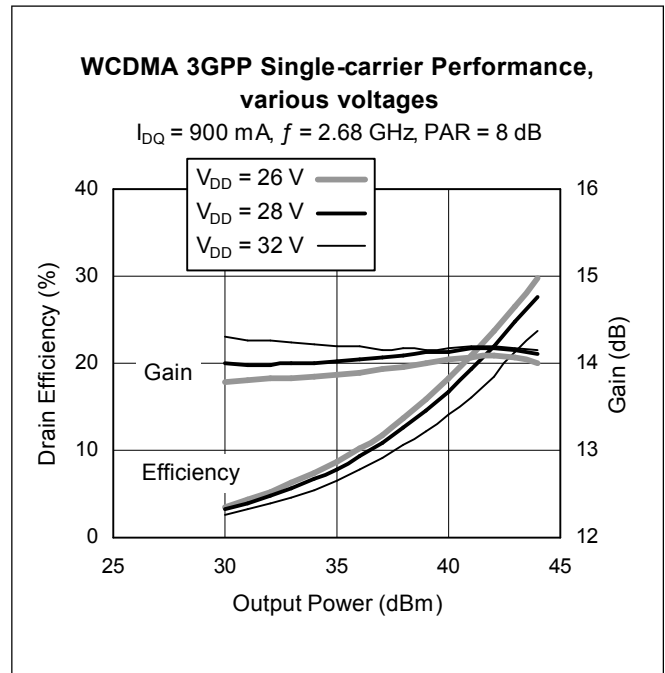
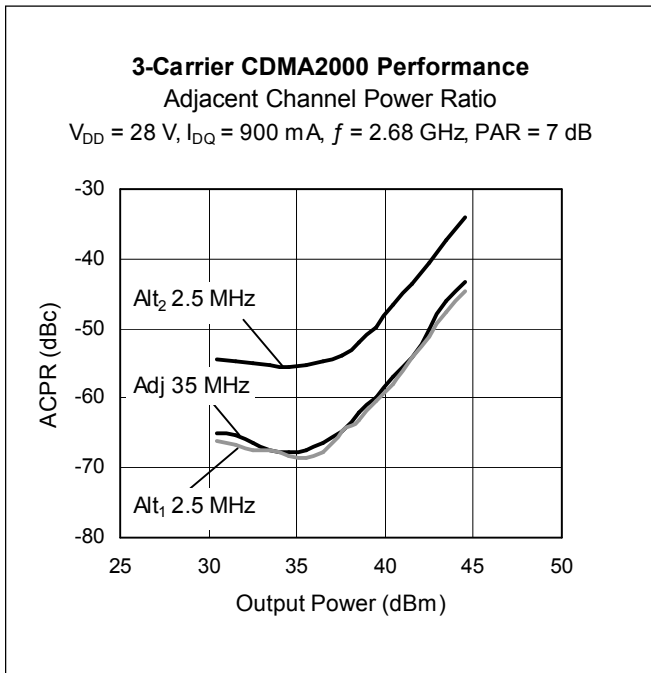
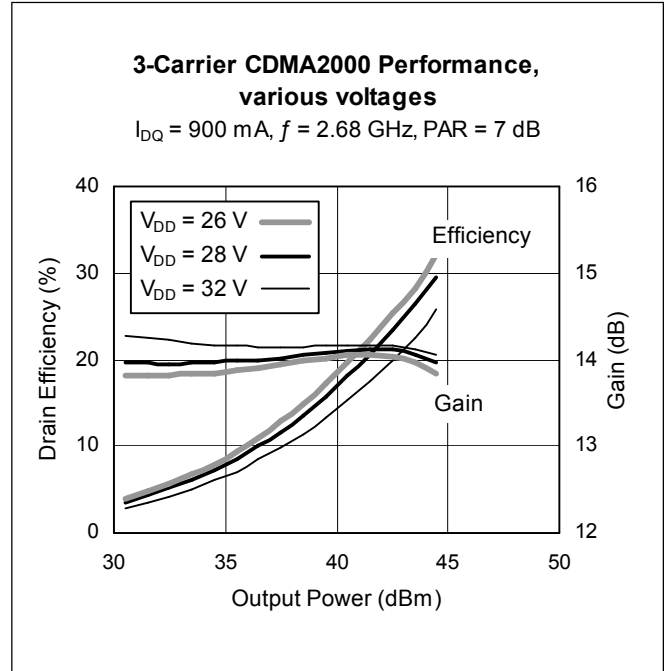
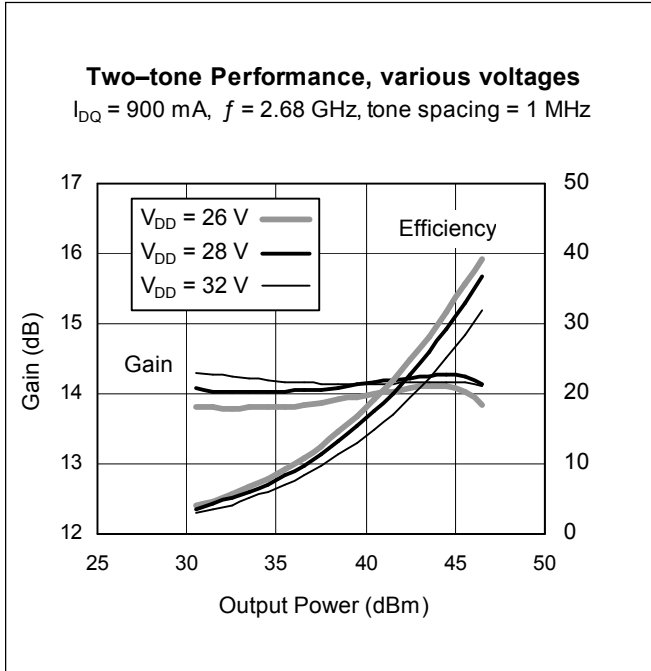

Typical Performance (cont.)

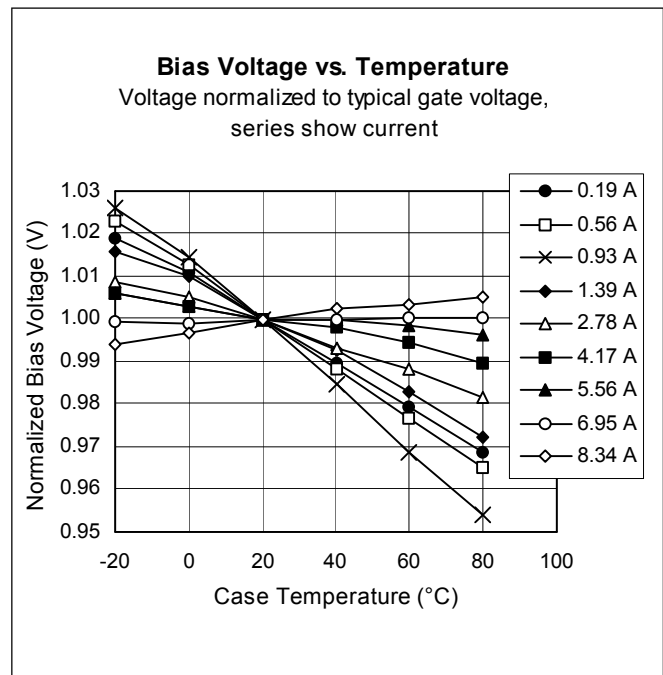
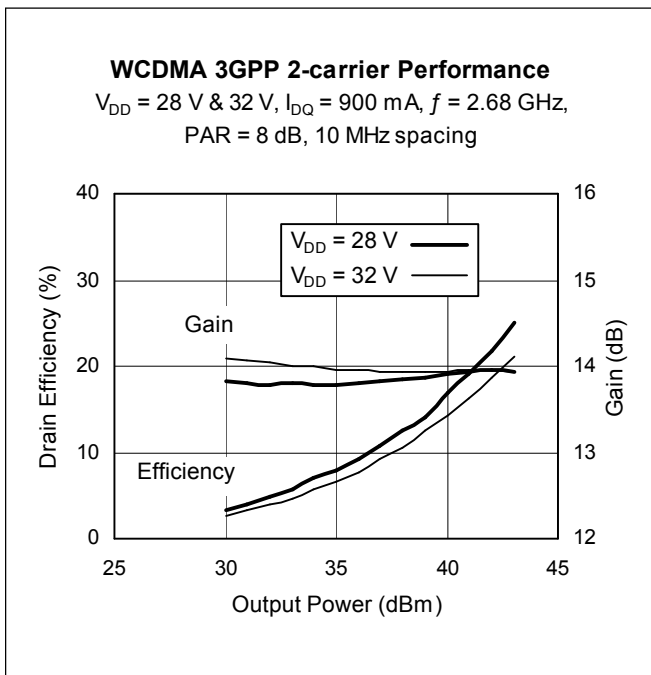
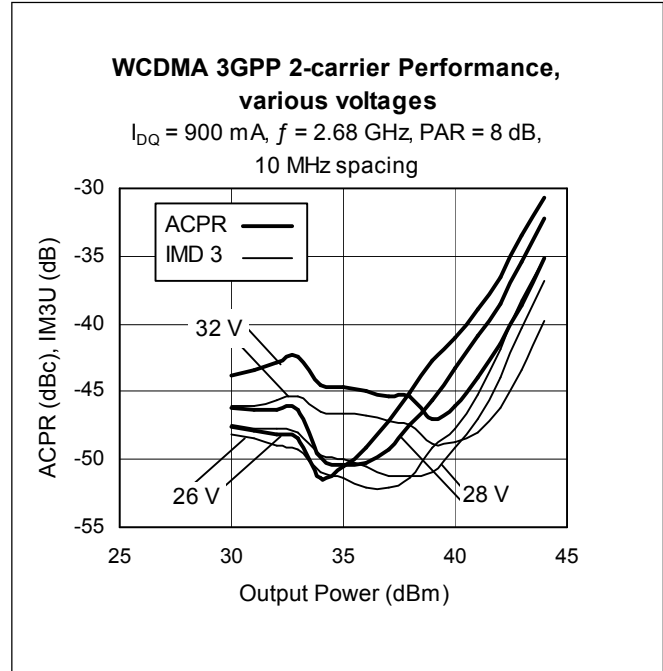
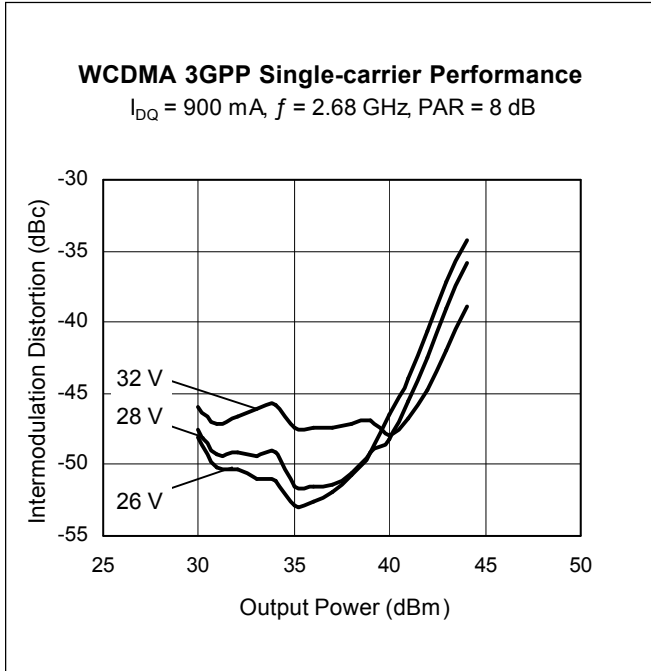

### Broadband Circuit Impedance

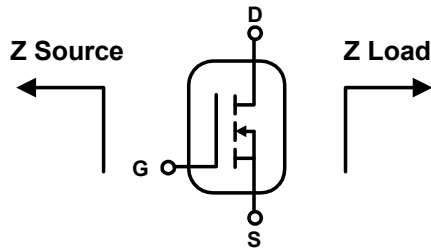

Frequency MHz	Z Source W		Z Load W	
	R	jX	R	jX
2600	4.4	3.8	1.8	2.5
2620	4.4	3.9	1.8	2.7
2650	4.3	4.2	1.7	2.9
2680	4.2	4.5	1.7	3.2
2700	4.2	4.7	1.6	3.3

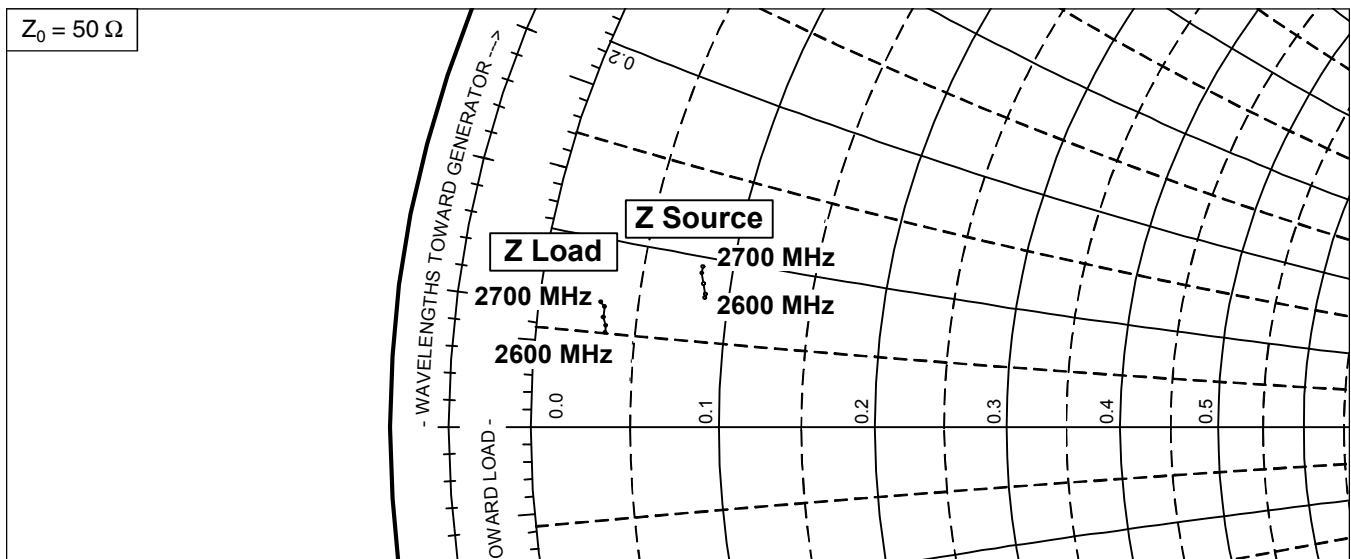

See next page for circuit information

### Reference Circuit

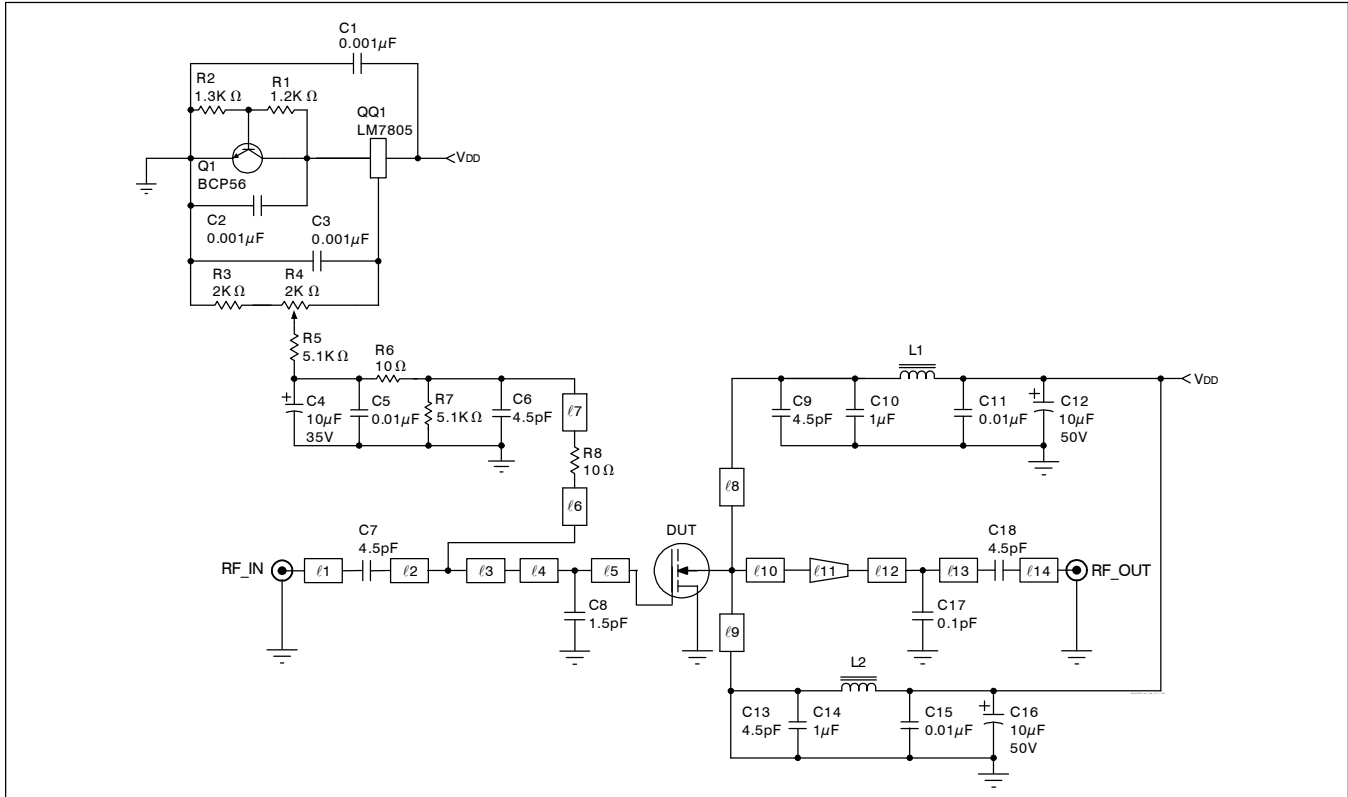

Reference circuit schematic for  $f = 2650$  MHz

#### Circuit Assembly Information

DUT	PTFA260851E or PTFA260851F	LDMOS Transistor	
PCB	0.76 mm [0.030"] thick, $\epsilon_r = 4.5$	TMM4	2 oz. copper

Microstrip	Electrical Characteristics at 2650 MHz	Dimensions: L x W ( mm )	Dimensions: L x W ( in. )
$l_1$	$0.121 \lambda$ , 46.9 $\Omega$	7.42 x 1.52	0.292 x 0.060
$l_2$	$0.135 \lambda$ , 40.5 $\Omega$	8.20 x 1.93	0.323 x 0.076
$l_3$	$0.021 \lambda$ , 40.5 $\Omega$	1.27 x 1.93	0.050 x 0.076
$l_4$	$0.028 \lambda$ , 14.7 $\Omega$	1.60 x 7.54	0.063 x 0.297
$l_5$	$0.079 \lambda$ , 8.3 $\Omega$	4.37 x 14.66	0.172 x 0.577
$l_6$	$0.008 \lambda$ , 57.9 $\Omega$	0.51 x 1.04	0.020 x 0.041
$l_7$	$0.272 \lambda$ , 57.9 $\Omega$	16.79 x 1.04	0.661 x 0.041
$l_8$	$0.278 \lambda$ , 49.3 $\Omega$	16.89 x 1.40	0.665 x 0.055
$l_9$	$0.278 \lambda$ , 49.3 $\Omega$	16.89 x 1.40	0.665 x 0.055
$l_{10}$	$0.060 \lambda$ , 5.2 $\Omega$	3.28 x 24.36	0.129 x 0.959
$l_{11}$ (taper)	$0.113 \lambda$ , 5.2 $\Omega$ / 49.3 $\Omega$	6.73 x 24.36 / 1.40	0.265 x 0.959 / 0.055
$l_{12}$	$0.048 \lambda$ , 49.3 $\Omega$	2.97 x 1.40	0.117 x 0.055
$l_{13}$	$0.095 \lambda$ , 49.3 $\Omega$	5.84 x 1.40	0.230 x 0.055
$l_{14}$	$0.070 \lambda$ , 49.3 $\Omega$	4.29 x 1.40	0.169 x 0.055



Reference Circuit (cont.)

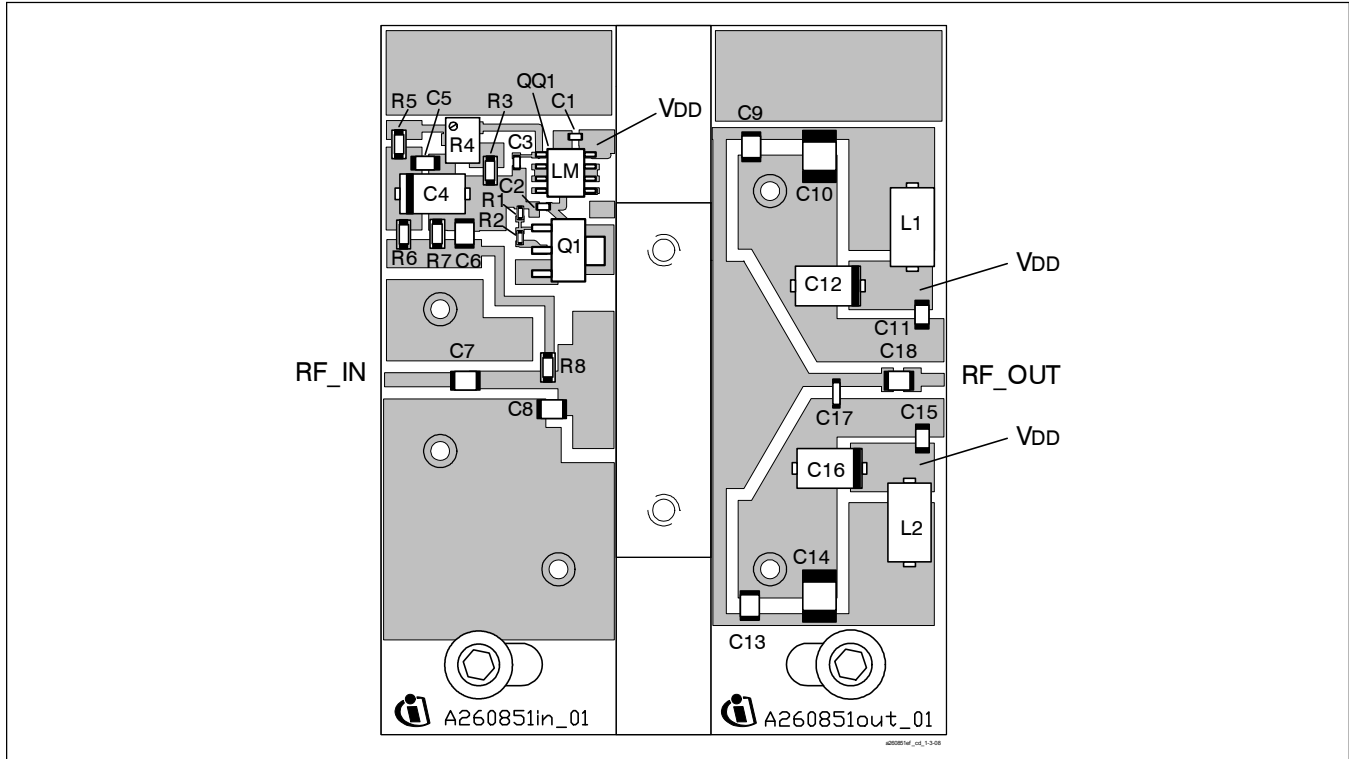

Reference circuit assembly diagram (not to scale)\*

Component	Description	Suggested Manufacturer	P/N or Comment
C1, C2, C3	Capacitor, 0.001 $\mu$ F	Digi-Key	PCC1772CT-ND
C4	Tantalum capacitor, 10 $\mu$ F, 35 V	Digi-Key	399-1655-2-ND
C5, C11, C15	Capacitor, 0.01 $\mu$ F	ATC	200B 103
C6, C7, C9, C13, C18	Ceramic capacitor, 4.5 pF	ATC	100B 4R5
C8	Ceramic capacitor, 1.5 pF	ATC	100B 1R5
C10, C14	Capacitor, 1 $\mu$ F	ATC	920C105
C12, C16	Tantalum capacitor, 10 $\mu$ F, 50 V	Garrett Electronics	TPSE106K050R0400
C17	Ceramic capacitor, 0.1 pF	ATC	100A 0R1
L1, L2	Ferrite, 8.9 mm	Elna Magnetics	BDS 4.6/3/8.9-4S2
Q1	Transistor	Infineon Technologies	BCP56
QQ1	Voltage regulator	National Semiconductor	LM7805
R1	Chip resistor 1.2 k-ohms	Digi-Key	P1.2KGCT-ND
R2	Chip resistor 1.3 k-ohms	Digi-Key	P1.3KGCT-ND
R3	Chip resistor 2 k-ohms	Digi-Key	P2KECT-ND
R4	Potentiometer 2 k-ohms	Digi-Key	3224W-202ETR-ND
R5, R7	Chip resistor 5.1 k-ohms	Digi-Key	P5.1KECT-ND
R6, R8	Chip resistor 10 ohms	Digi-Key	P10ECT-ND

\*Gerber Files for this circuit available on request



## Package Outline Specifications

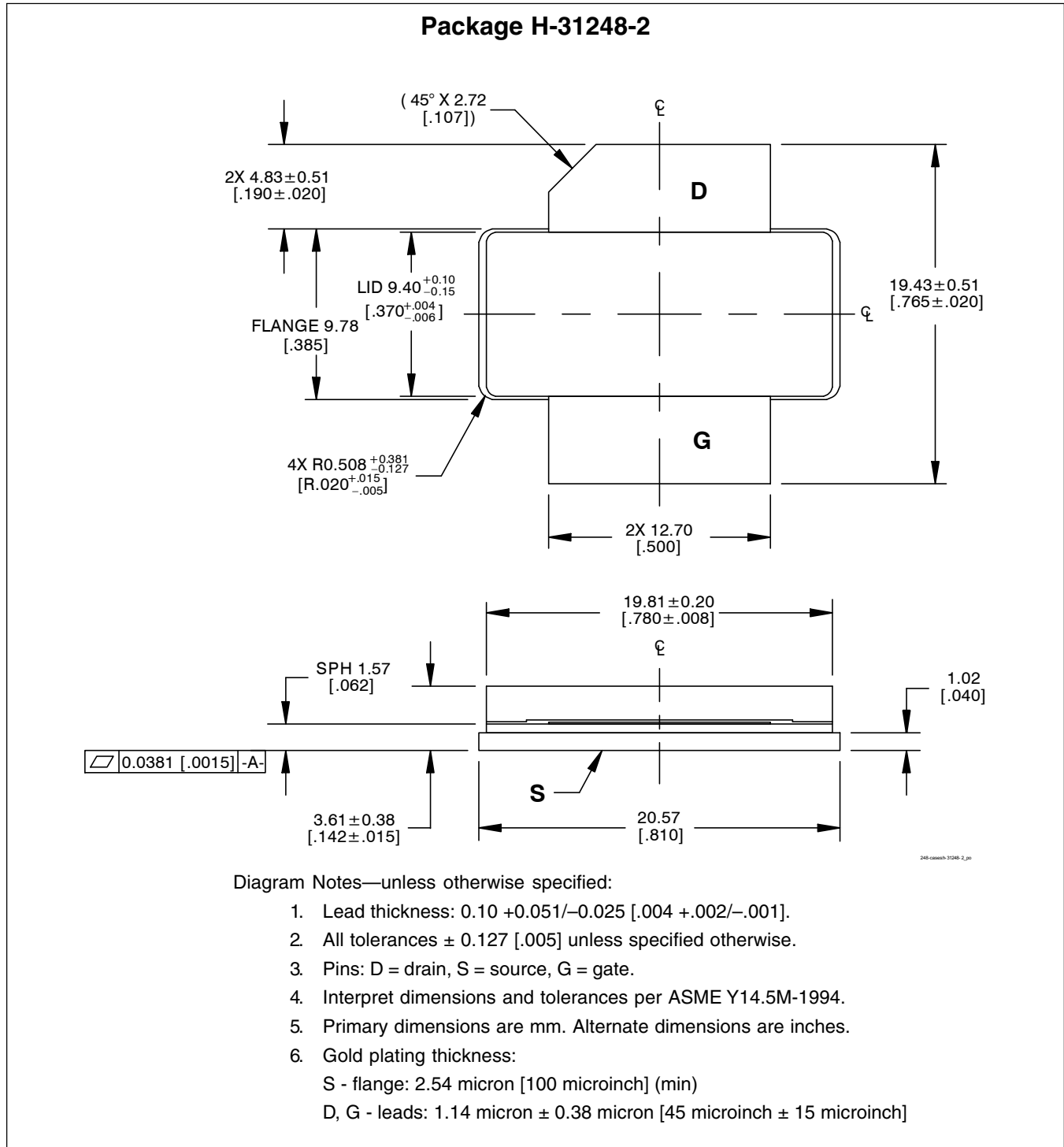

Find the latest and most complete information about products and packaging at the Infineon Internet page  
<http://www.infineon.com/products>

Revision History: 2009-02-20

Data Sheet

Previous Version: 2006-07-21, Preliminary Data Sheet

Page	Subjects (major changes since last revision)
6, 7	Add impedance and circuit information.
1	Increase bandwidth from 2620 – 2680 to 2500 – 2700.
8	Fixed typing error

### We Listen to Your Comments

Any information within this document that you feel is wrong, unclear or missing at all?

Your feedback will help us to continuously improve the quality of this document.

Please send your proposal (including a reference to this document) to:

[highpowerRF@infineon.com](mailto:highpowerRF@infineon.com)

To request other information, contact us at:  
 +1 877 465 3667 (1-877-GO-LDMOS) USA  
 or +1 408 776 0600 International

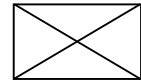

GOLDMOS® is a registered trademark of Infineon Technologies AG.

Edition 2009-02-20

Published by

Infineon Technologies AG  
 81726 München, Germany

© Infineon Technologies AG 2009.

All Rights Reserved.

### Legal Disclaimer

The information given in this document shall in no event be regarded as a guarantee of conditions or characteristics ("Beschaffheitsgarantie"). With respect to any examples or hints given herein, any typical values stated herein and/or any information regarding the application of the device, Infineon Technologies hereby disclaims any and all warranties and liabilities of any kind, including without limitation warranties of non-infringement of intellectual property rights of any third party.

### Information

For further information on technology, delivery terms and conditions and prices please contact your nearest Infineon Technologies Office ([www.infineon.com/rfpower](http://www.infineon.com/rfpower)).

### Warnings

Due to technical requirements components may contain dangerous substances. For information on the types in question please contact your nearest Infineon Technologies Office.

Infineon Technologies Components may only be used in life-support devices or systems with the express written approval of Infineon Technologies, if a failure of such components can reasonably be expected to cause the failure of that life-support device or system, or to affect the safety or effectiveness of that device or system. Life support devices or systems are intended to be implanted in the human body, or to support and/or maintain and sustain and/or protect human life. If they fail, it is reasonable to assume that the health of the user or other persons may be endangered.